

MECHANICAL DATA

Bulb	T-3
Base	E8-10, Subminiature Button Flexible Leads
Outline	JETEC 3-1
Basing	8DC
Cathode	Coated Unipotential
Mounting Position	Any

RATINGS¹ (Absolute Maximum)

Impact Acceleration	450 G
Uniform Acceleration	1000 G
Fatigue (Vibrational Acceleration for Extended Periods)	2.5 G
Bulb Temperature	220° C
Altitude ²	60000 Ft.

ELECTRICAL DATA

HEATER CHARACTERISTICS

	Min.	Bogey	Max.
Heater Voltage ³	6.0	6.3	6.6 V
Heater Current		150	mA

DIRECT INTERELECTRODE CAPACITANCES

	Shielded ⁴	Unshielded
Grid No. 1 to Plate	0.015	0.03 μ f Max.
Input	4.2	4.0 μ f
Output	3.4	1.9 μ f

RATINGS^{1, 5} (Absolute Maximum)

Plate Voltage	165 Vdc
Peak Plate Forward Voltage ⁶	330 v
Grid No. 3 Voltage	22 Vdc
Grid No. 2 Voltage	155 Vdc
Plate Dissipation	1.1 W
Grid No. 2 Dissipation	0.55 W
Cathode Current	16.5 mAdc
Grid No. 1 Voltage	
Positive Value	0 Vdc
Negative Value	55 Vdc
Heater-Cathode Voltage	
Heater Positive with Respect to Cathode	200 v
Heater Negative with Respect to Cathode	200 v
Grid No. 1 Circuit Resistance	1.1 Meg

CHARACTERISTICS

Plate Voltage	100 Vdc
Grid No. 3 Voltage	0 Vdc
Grid No. 2 Voltage	100 Vdc
Cathode Resistor	150 Ohms
Plate Current	7.5 mAdc
Grid No. 2 Current	2.4 mAdc
Transconductance	5000 μ mhos
Plate Resistance	260,000 Ohms
Grid No. 1 Voltage for $I_b = 50 \mu$ Adc Max.	-9.0 Vdc

NOTES:

1. Limitations beyond which normal tube performance and tube life may be impaired.
2. If altitude rating is exceeded, reduction of instantaneous voltage (Ef excluded) may be required.
3. Tube life and reliability of performance are directly related to the degree of regulation of the heater voltage to its center rated value of 6.3 volts.
4. External shield of 0.405 inch diameter connected to cathode.
5. Values shown are as registered with RETMA.
6. Per MIL-E-1C par. 6.5 and General Section of this Sylvania Subminiature Tube Manual titled Specifications and Ratings.

QUICK REFERENCE DATA

The Premium Subminiature Type 6205 is a sharp cutoff pentode having an external Grid No. 3 connection. It is otherwise identical to the 5840. The 6205 is well suited to amplifier service at frequencies up to 900 mc and is designed to provide dependable operation under conditions of severe shock, vibration, high temperature and high altitude.

It is manufactured and inspected to meet the applicable MIL-E-1 specification for reliable operation.

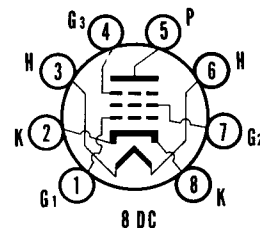
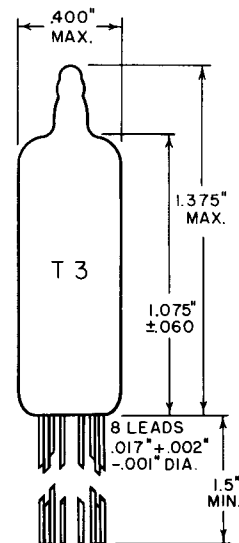

**SYLVANIA ELECTRIC
PRODUCTS INC.**

**RADIO TUBE DIVISION
EMPORIUM, PA.**

Prepared and Released By The
TECHNICAL PUBLICATIONS SECTION
EMPORIUM, PENNSYLVANIA

FEBRUARY 1957

PAGE 1 OF 12

ACCEPTANCE CRITERIA

Test Conditions

Heater Voltage	6.3 V
Plate Voltage	100 Vdc
Grid No. 1 Voltage	0 V
Grid No. 2 Voltage	100 Vdc

Grid No. 3 Voltage MIL-E-1 Par. 3.2.2.1 Note 4	0 V
Heater-Cathode Voltage MIL-E-1 Par. 3.2.2.1	0 V
Cathode Resistor	150 Ohms

For the purposes of inspection, use applicable reliable paragraphs of MIL-E-1 and Inspection Instructions for Electron Tubes.

MIL-E-1 Ref.	Test	AQL (%)	Limits					Units
			Min.	LAL	Bogey	UAL	Max.	
Measurements Acceptance Tests, Part 1, Note 1								
4.1.1.7 4.10.8	(Method A) Heater Current: ALD = 12	—	—	144	150	156	—	mA
4.10.8	Heater Current:	0.65	140	—	—	—	160	mA
4.10.15	Heater-Cathode Leakage:	0.65	—	—	—	—	—	—
	Ehk = +100 Vdc	—	—	—	—	—	5.0	μA _{dc}
	Ehk = -100 Vdc	—	—	—	—	—	5.0	μA _{dc}
4.10.6.1	Grid Current: Ic1 Rg1 = 1.0 Meg	0.65	0	—	—	—	-0.3	μA _{dc}
4.1.1.7 4.10.4.1	(Method A) Plate Current (1): ALD = 2.3	—	—	6.7	7.5	8.3	—	mA _{dc}
4.10.4.1	Plate Current (1):	0.65	5.5	—	—	—	9.5	mA _{dc}
4.10.4.1	Plate Current (2): Ec1 = -9.0 Vdc; Rk = 0 Ohms	0.65	—	—	—	—	50	μA _{dc}
4.10.4.3	Screen Grid Current: Ic2	0.65	1.5	—	—	—	3.3	mA _{dc}
4.1.1.7 4.10.9	(Method A) Transconductance (1): ALD = 900 Sm	—	—	4700	5000	5300	—	μmhos
4.10.9	Transconductance (1): Sm	0.65	4200	—	—	—	5800	μmhos
4.7.5	Continuity and Shorts (Inoperatives):	0.4	—	—	—	—	—	—
4.9.1	Mechanical: Envelope (8-1)	—	—	—	—	—	—	—
Measurements Acceptance Tests, Part 2								
4.8.2	Insulation of Electrodes:	2.5	—	—	—	—	—	—
	g1-all	—	100	—	—	—	—	Meg
	p-all	—	100	—	—	—	—	Meg
4.10.9	Transconductance (2): Δ Sm Ef = 5.7 V Ef	2.5	—	—	—	—	10	%
4.10.6.2	Grid Emission: Note 5 Ef = 7.5 V; Ec1 = -9.0 Vdc; Rg1 = 1.0 Meg; Rk = 0 Ohms	2.5	0	—	—	—	-0.5	μA _{dc}
4.10.3.2	AF Noise: Esig = 70 mVac; Ec2 = 19 Vdc; Rg1 = 0.1 Meg; Rg2 = 1000 Ohms; Rp = 0.2 Meg; Ck = 1000 μf	2.5	—	—	—	—	17	VU
4.10.10	Plate Resistance:	6.5	0.175	—	—	—	—	Meg
4.10.14	Capacitance:	6.5	—	—	—	—	—	—
	0.405 In. Dia. Shield Cg1p	—	—	—	—	—	0.015	μμf
	0.405 In. Dia. Shield Cg1	—	3.5	—	—	—	4.9	μμf
	0.405 In. Dia. Shield Cout	—	2.9	—	—	—	3.9	μμf
4.9.12.1	Low Pressure Voltage Breakdown: Pressure = 20 ± 5 mm Hg.; Voltage = 300 Vac	6.5	—	—	—	—	—	—

ACCEPTANCE CRITERIA (Continued)

MIL-E-1 Ref.	Test	AQL (%)	Limits					Units
			Min.	LAL	Bogey	UAL	Max.	
Measurements Acceptance Tests, Part 2 (Continued)								
4.9.20.3	Vibration (1): No Voltages; Post Shock and Fatigue Test End Points Apply	10.0	—	—	—	—	—	
4.9.19.1	Vibration (2): Rp = 10,000 Ohms; Ck = 1000 μf; F = 40 cps; G = 15	2.5	—	—	—	—	60	mVac
4.9.19.1	White Noise: Note 6 Rp = 10,000 Ohms; Ck = 1000 μf; Peak Acceleration = 15 G	2.5	—	—	—	—	800	mv pk-pk
		2.5	—	—	—	—	150	mVac
Degradation Rate Acceptance Tests, Note 2								
4.9.5.3	Subminiature Lead Fatigue:	2.5	4	—	—	—	—	arcs
4.9.20.5	Shock: Hammer Angle = 30°; Ehk = +100 Vdc; Rg1 = 0.1 Meg . . .	20	—	—	—	—	—	
4.9.20.6	Fatigue: G = 2.5; Fixed Frequency; F = 25 min., 60 max.	6.5	—	—	—	—	—	
— — — —	Post Shock and Fatigue Test End Points:							
	Vibration (2)	—	—	—	—	—	200	mVac
	Heater-Cathode Leakage							
	Ehk = +100 Vdc	—	—	—	—	—	20	μAdc
	Ehk = -100 Vdc	—	—	—	—	—	20	μAdc
	Change in Transconductance (1) of Individual Tubes ΔS_{m_t}	—	—	—	—	—	20	%
4.9.6.3	Glass Strain:	6.5	—	—	—	—	—	

MIL-E-1 Ref.	Test	AQL (%)	Allowable Defectives per Characteristic		Limits		Units
			1st Sample	Combined Samples	Min.	Max.	
Acceptance Life Tests, Note 2							
4.11.7	Heater Cycling Life Test: Ef = 7.0 V; 1 min. on, 4 min. off; Ehk = 140 Vac; Ec1 = Ec2 = Ec3 = Eb = 0 V	2.5	—	—	—	—	
4.11.3.1	Stability Life Test: (1 Hour) Ehk = +200 Vdc; Rg1 = 1.0 Meg; TA = Room	1.0	—	—	—	—	
4.11.4	Stability Life Test End Points: Change in Transconductance (1) of Individual Tubes ΔS_{m_t}	—	—	—	—	10	%
4.11.3.1	Survival Rate Life Test: (100 Hours) Stability Life Test Conditions or Equivalent; TA = Room . . .	—	—	—	—	—	
4.11.3.1.1		—	—	—	—	—	
4.11.4	Survival Rate Life Test End Points: Continuity and Shorts (Inoperatives) Transconductance (1) Sm	0.65 1.0	—	—	—	—	μmhos
4.11.5	Intermittent Life Test: Note 3 Stability Life Test Conditions; T Envelope = +220°C min.; 1000 Hour Requirements Do Not Apply	—	—	—	—	—	
4.11.3.1		—	—	—	—	—	

ACCEPTANCE CRITERIA (Continued)

MIL-E-1 Ref.	Test	AQL (%)	Allowable Defectives per Characteristic		Limits		Units	
			1st Sample	Combined Samples	Min.	Max.		
Acceptance Life Tests, Note 2 (Continued)								
4.11.3.1	Intermittent Life Test End Points: (500 Hours)							
4.11.4								
		Inoperatives.....	—	1	3	—	—	
		Grid Current I _{g1}	—	1	3	0	-0.8	μAdc
		Heater Current.....	—	2	5	138	164	mA
		Change in Transconductance (1) of Individual Tubes Δ S _m	—	1	3	—	20	%
		Transconductance (2) Δ S _m	—	2	5	—	15	%
		Heater-Cathode Leakage.....	—	2	5	—	—	
		E _{hk} = +100 Vdc.....	—	—	—	—	10	μAdc
		E _{hk} = -100 Vdc.....	—	—	—	—	10	μAdc
		Insulation of Electrodes.....	—	2	5	—	—	
		g1-all.....	—	—	—	50	—	Mcg
		p-all.....	—	—	—	50	—	Mcg
		Transconductance (1) Average Change, Avg Δ S _m	—	—	—	—	15	%
		Total Defectives.....	—	4	8	—	—	

ACCEPTANCE CRITERIA NOTES:

- The AQL for the combined defectives for attributes in Measurements Acceptance Tests, Part 1, excluding inoperatives and mechanical shall be one (1) percent. A tube having one (1) or more defects shall be counted as one (1) defective.
- Tubes subjected to the following destructive tests are not to be accepted under this specification.
 - 4.9.5.3 Subminiature lead fatigue
 - 4.9.20.5 Shock
 - 4.9.20.6 Fatigue
 - 4.11.7 Heater cycling life test
 - 4.11.5 Intermittent life test
- Envelope temperature is defined as the highest temperature indicated when using a thermocouple of # 40 BS or smaller diameter elements welded to a ring of 0.025 inch diameter phosphor bronze placed in contact with the envelope. Envelope temperature requirement will be satisfied if a tube, having bogey I_b (±5%) under normal test conditions, is determined to operate at maximum specified temperature at any position on the life test rack.
- Types 5840 and 6205 are the same except for suppressor grid and cathode connection. Type 6205 has not been designed for control or gating purposes using the number 3 grid.
- Prior to this test, tubes shall be preheated five (5) minutes at conditions indicated below. Test within three (3) seconds after preheating. Three-minute test is not permitted. Grid Emission shall be the last test performed on the sample selected for the Grid Emission Test.

Ef	Ec1	Ec2	Ec3	Eb	Rk	Rg1
V	Vdc	Vdc	Vdc	Vdc	Ohms	Mcg
7.5	0	100	0	100	150	1.0

6: The tube shall be rigidly mounted on a table vibrating such that the instantaneous values of acceleration shall constitute approximately a "White Noise" spectrum which is free from discontinuities from 100 cps to 5000 cps. The spectrum of instantaneous acceleration shall be such that each octave of bandwidth delivers 2.3 G's rms acceleration. With this the case, the rms value of acceleration for any bandwidth within the specified spectrum is equal to

$$G_{rms} = 2.3 G \sqrt{3.32 \log_{10} (f_2/f_1)}$$

f₂ and f₁ are the upper and lower frequencies respectively of the band under consideration. The degree of clipping of the peak accelerations shall be such that the peak value of acceleration is at least 15 G's.

The voltage (ep) produced across the resistor (Rp) as a result of vibration shall be coupled through a compensating amplifier to a low pass filter. The compensating amplifier shall have a high input impedance (0.25 megohm or more) and shall be adjusted to compensate for any insertion losses in the filter. The combined frequency response of amplifier and filter shall be flat within ±0.5 db from 50 cps to 8000 cps, shall be down no more than 5 db at 10,000 cps and at 20 cps, and down at least 40 db at 13,000 cps. For reading the peak to peak value of output voltage the filter output shall be fed directly to the input of a Ballantine Model 305 peak to peak electronic voltmeter or equal, while the rms value shall be measured with a Hewlett-Packard Model 400C or equal.

APPLICATION DATA

The 6205 is a Premium Subminiature, sharp cutoff pentode having an external suppressor grid connection. Electrically, the 6205 is otherwise identical to the 5840. This type is characterized by long life and stable performance under conditions of severe shock, vibration, high altitude and high temperature.

The 6205 is intended for use as an rf amplifier at frequencies up to 400 mc, as well as many low frequency

applications. As the frequency of operation is increased, consideration should be given to the resultant decrease in input and output resistance, Figure 1. Assuming matched input and output impedance, approximate tube gain can be obtained from the formula:

$$\text{Voltage Gain} = \frac{gm \sqrt{R_{input} \times R_{output}}}{2}$$

APPLICATION DATA (Continued)

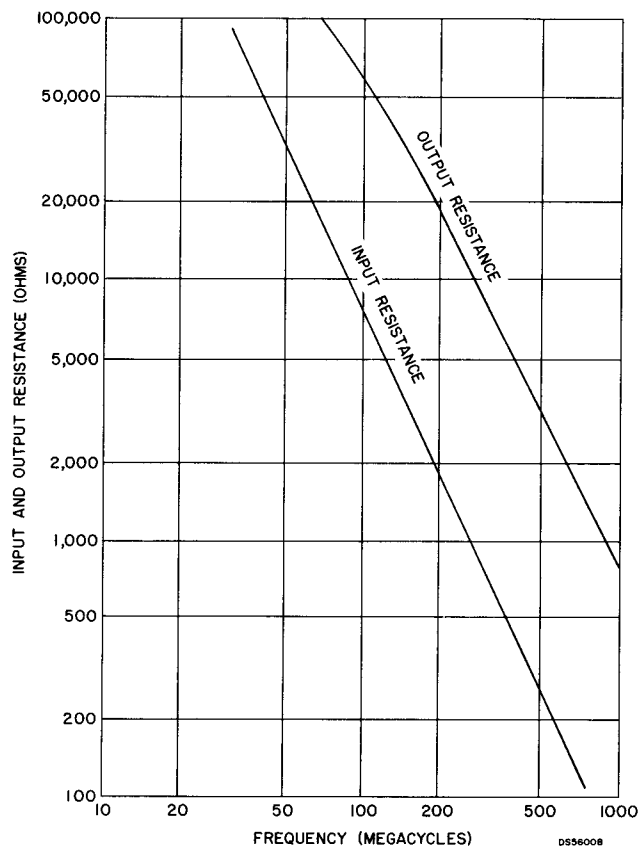

Figure 1—Input and output resistance vs frequency.

where the values of R_{input} and R_{output} are obtained from the curves of Figure 1. The use of this formula assumes matched impedances into and out of the amplifier stage under consideration. If the source impedance is lower than the input resistance or if the load resistance is higher than the output resistance, much greater voltage gain per stage can be obtained than that indicated by the above formula. The voltage gain of a matching circuit is equal to the square root of the impedance ratio.

In some applications it may be advantageous to place an unbypassed resistance in the cathode circuit to compensate for the change in input capacitance with bias. This unbypassed resistance reduces the effective gm of the tube by the factor

$$\frac{1}{1 + gm R_k \left(\frac{I_b + I_{c2}}{I_b} \right)}$$

However, it also has the effect of raising the input re-

sistance of the tube under certain operating conditions so that both a net increase in gain and a net decrease in input capacitance change may result. The 6205 is particularly well suited to such applications since the suppressor grid may be grounded directly, thus providing greater stability. It should be noted that the suppressor grid is not intended as a control electrode.

The self neutralization frequency of the 6205 is approximately 200 mc. At this point the inductance of the tube leads resonate with the grid plate capacitance to effect neutralization. At higher frequencies the feedback is inductive and takes place through the tube leads. Two cathode leads are provided to minimize this effect and permit isolation of the input and output circuits. The external suppressor grid connection also facilitates the possible employment of suppressor grid neutralization techniques*.

Resistance coupled amplifier data is presented in the accompanying table.

To insure correlation with actual field conditions and thereby enhance equipment reliability, vibrational noise output is controlled by the "white noise test" as shown in the acceptance criteria. Briefly, this test consists of subjecting the tube to a white noise vibration spectrum covering the frequency band of 100 to 5000 cps at a rms level of 2.3 g's per octave and a peak level of 15 g's. Limits are shown for both peak and rms output. A further discussion of the white noise vibrational test is included in the frontal section of this manual.

The 6205 is manufactured and inspected to meet the applicable Mil-E-1 specification for reliability.

Life expectancy is described by the life tests, specified on the attached pages and/or individual MIL-E-1 specifications. The actual life expectancy of the tubes in an operating circuit is affected by both the operating and environmental conditions involved. Likewise, the life tests specified indicate performance under certain operating criteria to a set of specified end points. Performance at conditions other than those specified can usually be estimated only roughly as giving better or poorer life expectancy. For further discussion of life expectancy, reference should be made to the frontal section of this manual.

When operated under conditions common to on-off control applications the tube exhibits freedom from the development of interface resistance. The heater-cathode construction is designed to withstand intermittent operation.

*"A Method of Neutralizing IF Amplifier Tubes at 44 Mc by Means of Suppressor Grid Reaction", Sylvania Engineering Information Service, Vol. 3, No. 1, April, 1956.

RESISTANCE COUPLED AMPLIFIER DATA

	Ebb = 100 Volts						Ebb = 150 Volts					
	0.100 0.220		0.270 0.680		0.470 1.20		0.100 0.270		0.270 0.820		0.470 1.50	
Rb (megohms).....												
Rc2 (megohms).....												
Rcf (megohms).....	0.27	0.47	0.47	1.0	0.47	1.0	0.27	0.47	0.47	1.0	0.47	1.0
Rk (ohms).....	820	820	2200	2200	3300	3300	560	560	1500	1500	2200	2200
Ib (ma).....	0.75	0.75	0.273	0.273	0.164	0.164	1.13	1.13	0.42	0.42	0.247	0.247
Ic2 (ma).....	0.292	0.292	0.102	0.102	0.062	0.062	0.41	0.41	0.143	0.143	0.083	0.083
Ec1 (volts).....	-0.855	-0.855	-0.825	-0.825	-0.746	-0.746	-0.862	-0.862	-0.845	-0.845	-0.726	-0.726
Ec2 (volts).....	35.8	35.8	31.4	31.4	25.5	25.5	39.3	39.3	32.8	32.8	25.6	25.6
Eb (volts).....	25.0	25.0	26.3	26.3	22.9	22.9	37.0	37.0	36.7	36.7	34.0	34.0
Esig (volts, rms).....	0.1	0.1	0.1	0.1	0.1	0.1	0.1	0.1	0.1	0.1	0.1	0.1
Eout (volts, rms).....	8.2	9.0	9.5	11.8	9.2	11.7	11.5	12.5	13.2	15.5	13.0	16.7
Gain.....	82	90	95	118	92	117	115	125	132	155	130	167
% Distortion.....	2.8	3.8	2.5	3.0	3.1	2.3	1.5	2.2	2.4	2.4	3.7	3.0
Esig* (volts, rms).....	0.23	0.22	0.15	0.16	0.12	0.14	0.20	0.18	0.16	0.16	0.11	0.14
Eout (volts, rms).....	17.7	18.6	13.6	17.0	11.0	16.0	21.7	21.7	20.5	24.0	14.0	22.2
Gain.....	77	85	91	106	92	114	109	120	128	150	127	159
% Distortion.....	4.9	4.8	4.7	4.4	4.8	5.0	4.8	5.0	4.9	4.8	4.2	4.8

*Maximum signal for 5% distortion or M microampere grid current.

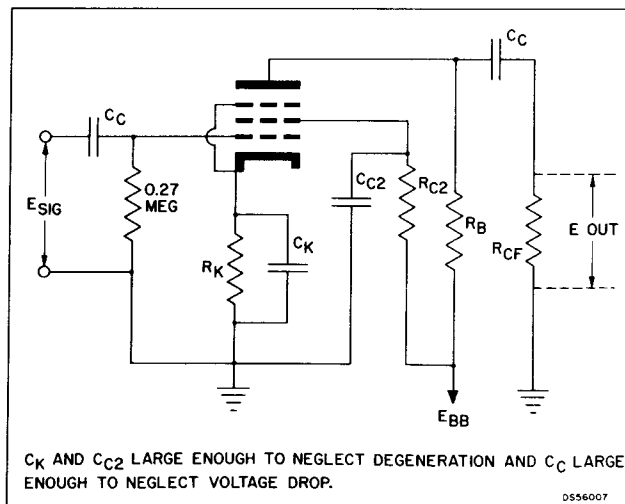

Resistance coupled amplifier circuit.
(Grid No. 3 externally connected to cathode)

AVERAGE PLATE CHARACTERISTICS
(PENTODE CONNECTED)

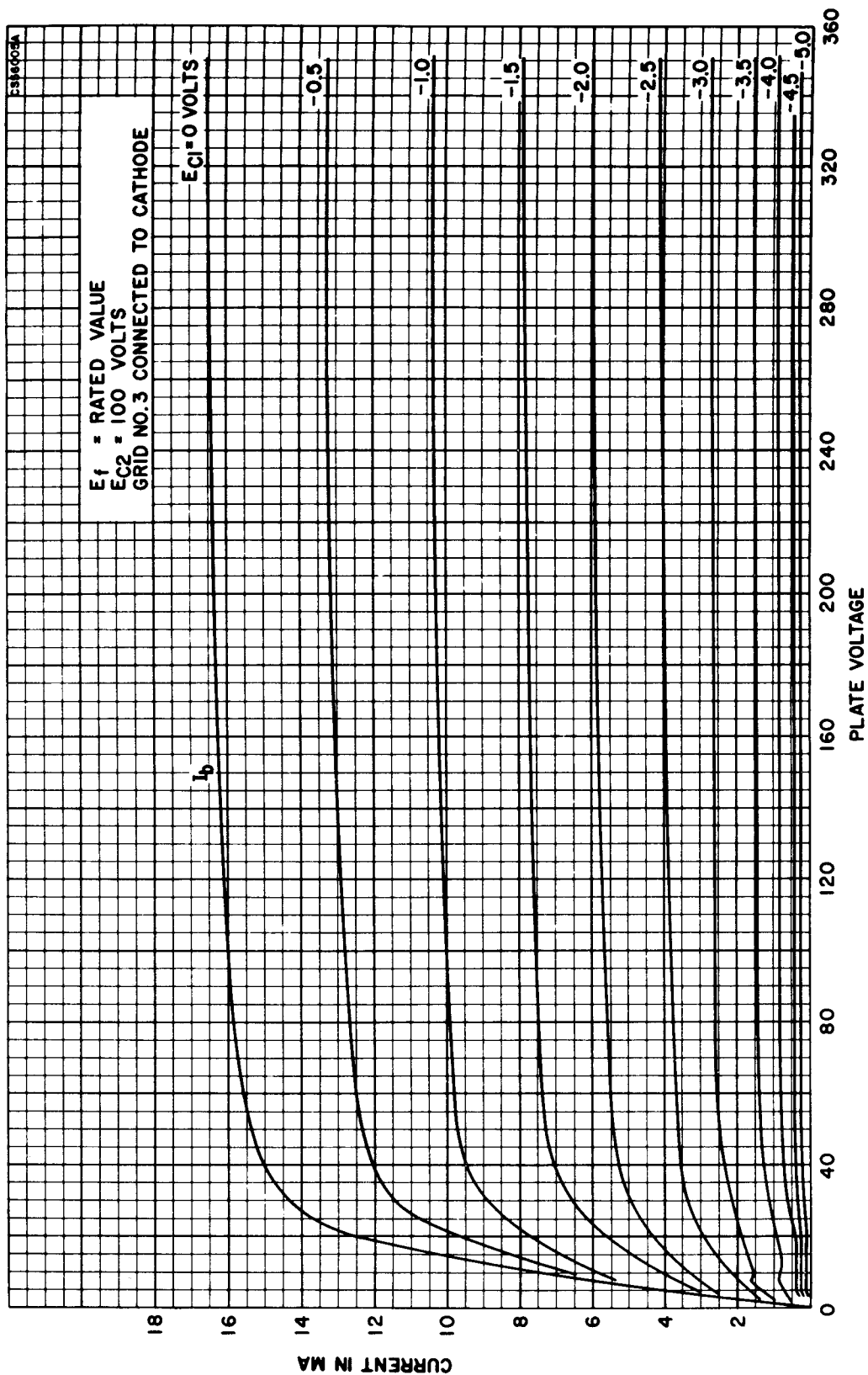

AVERAGE PLATE CHARACTERISTICS
(PENTODE CONNECTED)

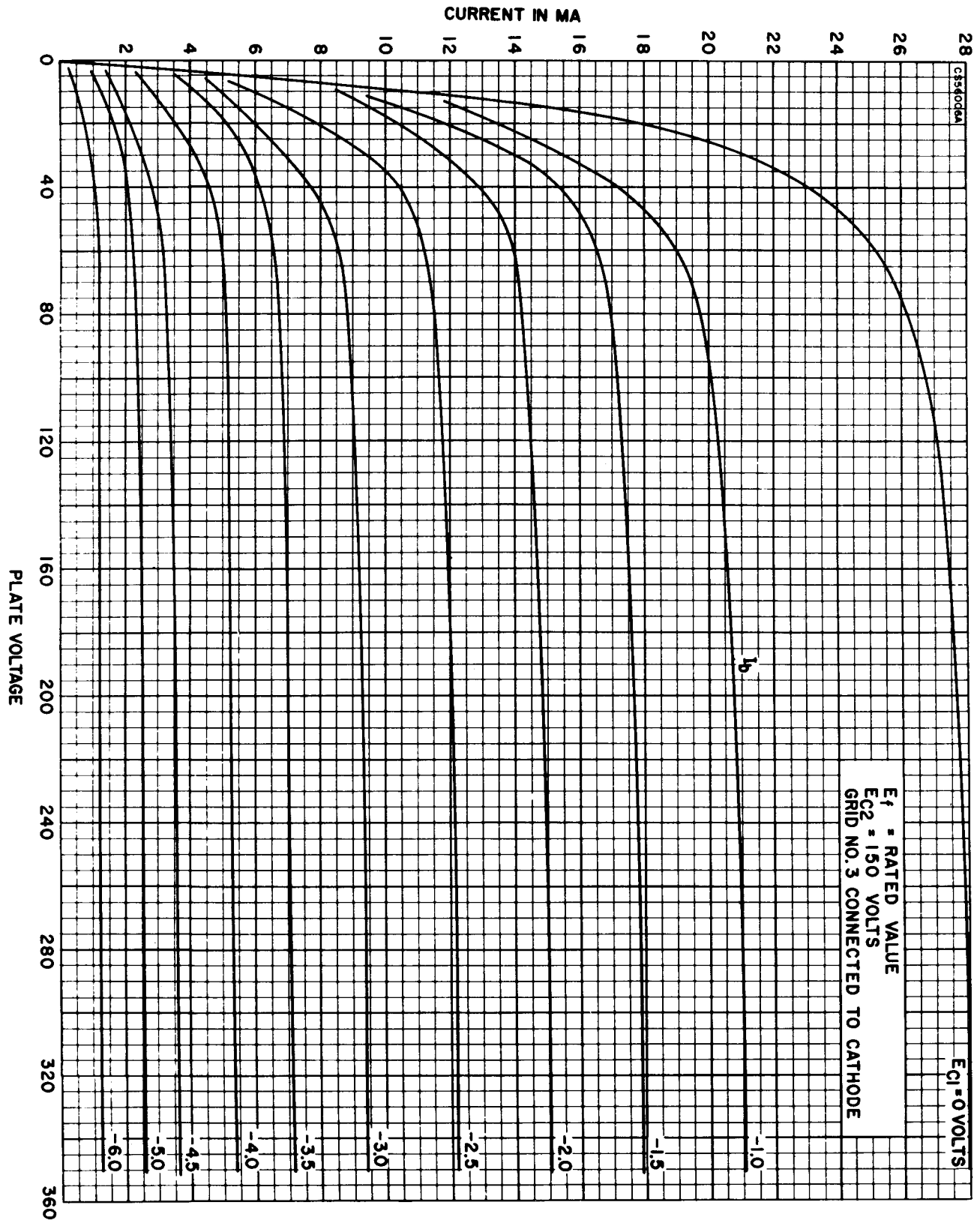

AVERAGE GRID No. 2 CHARACTERISTICS
(PENTODE CONNECTED)

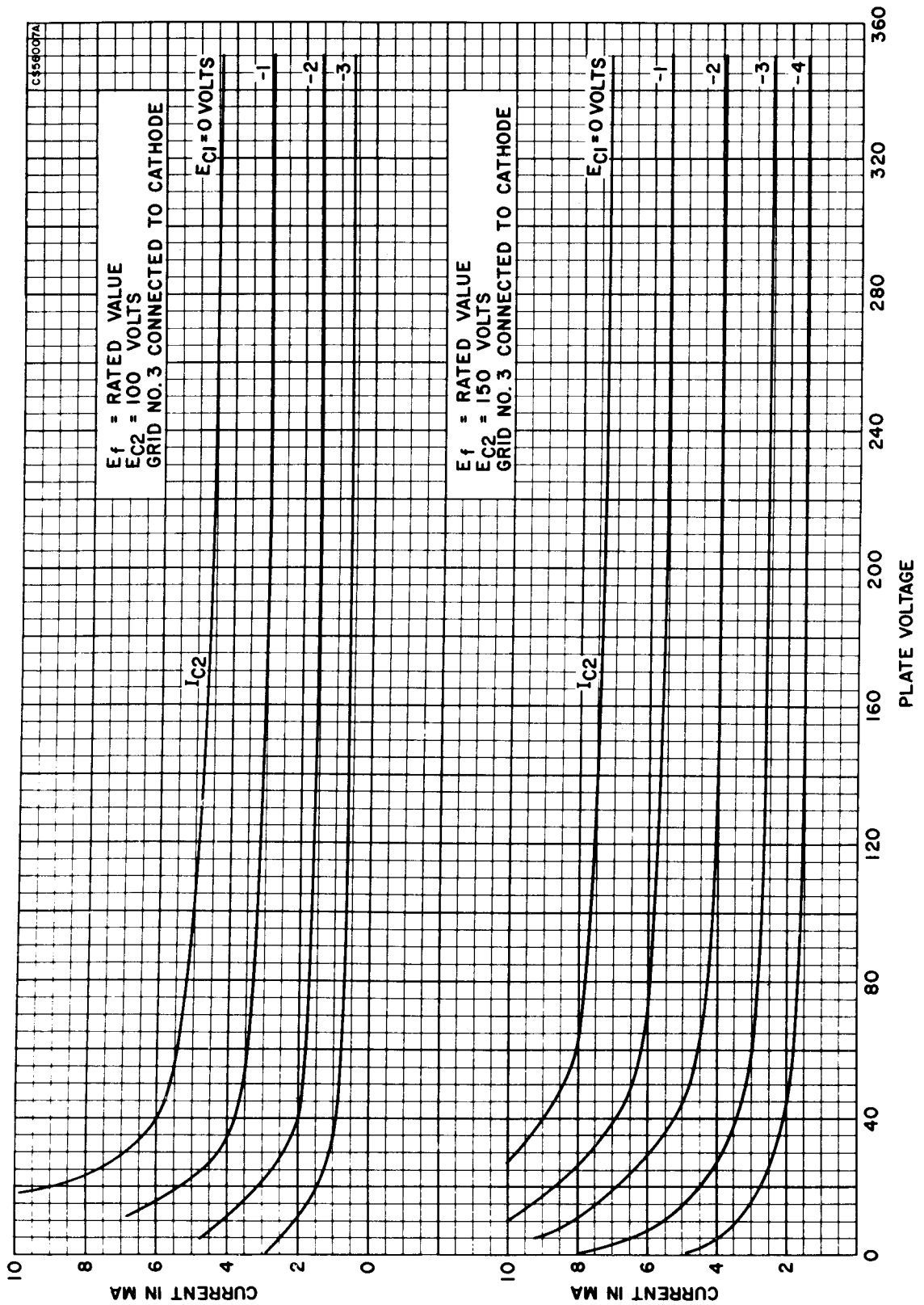

AVERAGE TRANSFER CHARACTERISTICS
(PENTODE CONNECTED)

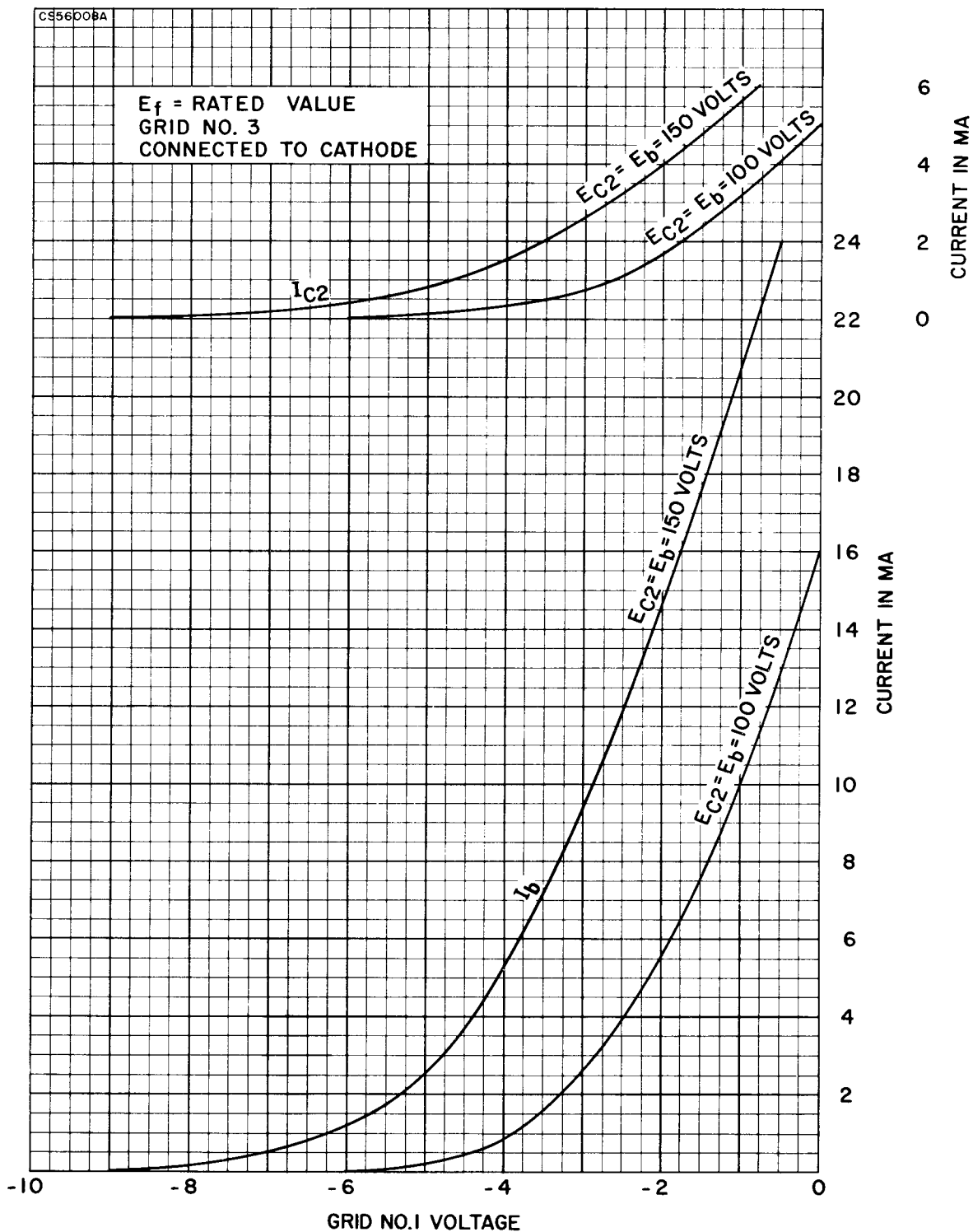

AVERAGE TRANSFER CHARACTERISTICS
(PENTODE CONNECTED)

